

ACCESSORY SETUP INSTRUCTION

PANNIER SET, SILVER (3-PIECE) -- PN 6WWV-808000-5000

VALID FOR: MY2023 and later Ibex 800 S, Ibex 800 T
TOP CASE INSTRUCTIONS SEPARATE (6WWV-803000-5000)

BEFORE YOU BEGIN: Read and understand the instructions before starting any work. Make sure that all parts are ready and that you have all the tools required for assembly.

NOTE: CFMOTO shall not be liable for any damage caused by incorrect assembly. CFMOTO recommends that all original accessories be assembled by an authorized CFMOTO dealer.

Before assembly, park the vehicle on a flat surface, and turn off the key switch.

Zhejiang CFMOTO Power Co., Ltd. All rights reserved. Reproduction of this document, even in part, as well as copying of all kinds, is permitted only with the express written permission of the copyright owner.

MEANING OF SYMBOLS

 - Indicates information with more details or tips.

 - Indicates information of warning or danger.

PARTS LIST:

| ITEM | PART NAME | PART NUMBER | QTY. | REMARK |
|------|------------------------------------|------------------|------|--------|
| 1 | SILVER ALUMINUM SIDE BOX ASSY(35L) | 6WWV-804000-5000 | 1 | |
| 2 | SILVER ALUMINUM SIDE BOX ASSY(28L) | 6WWV-805000-5000 | 1 | |

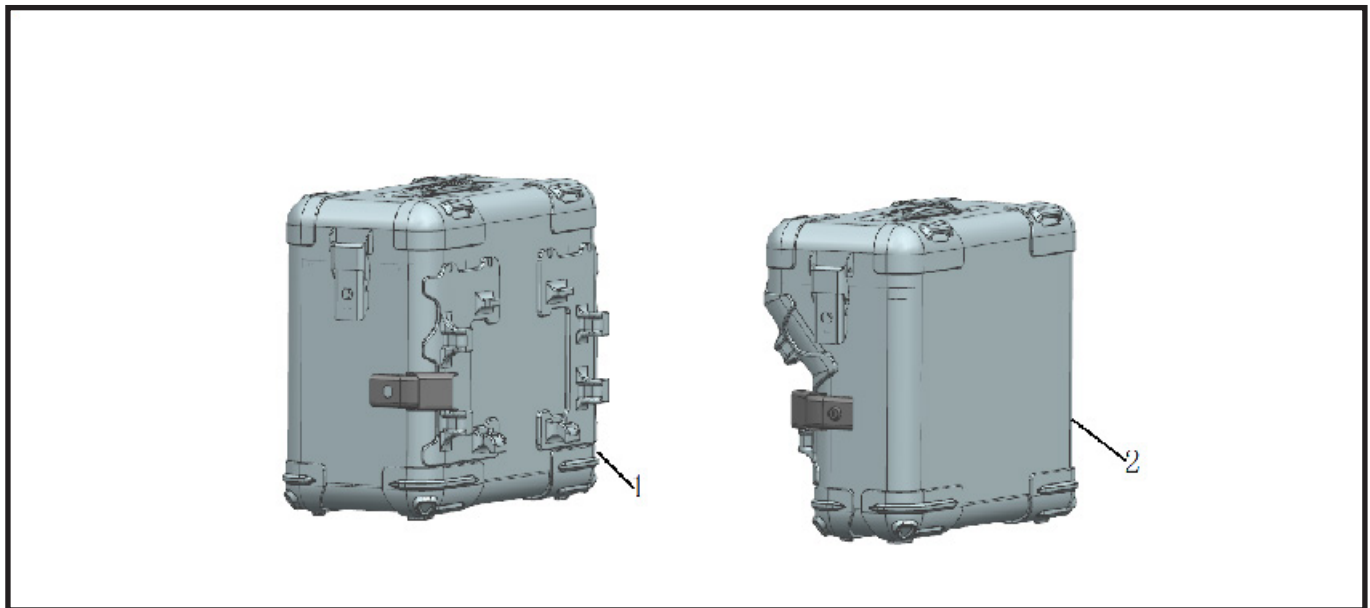

TOOL LIST:

| ITEM | DESCRIPTION | QTY. | REMARK |
|------|-------------------|------|-------------------|
| 1 | PROTECTIVE GLOVES | 1 | Recommended tools |

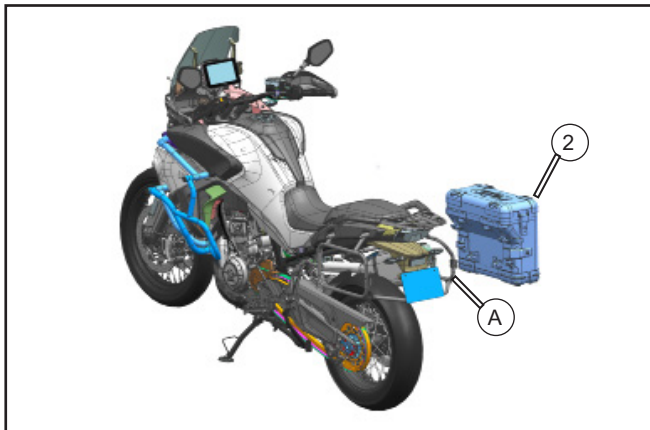
ASSEMBLY and INSTALLATION

// Position the side box (2) on the right bracket (A).

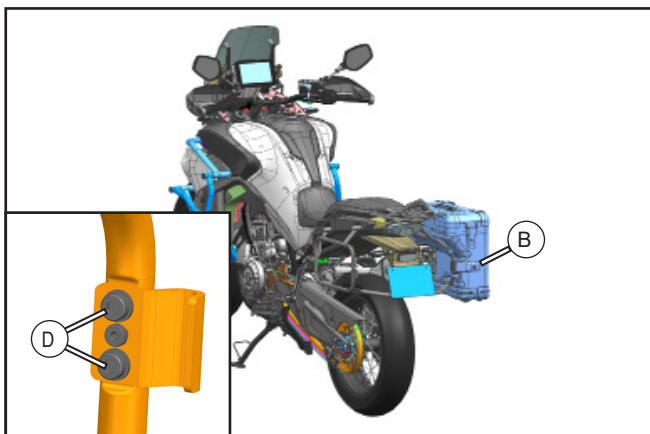

// Lock the shackle (B) to the right bracket, and then lock it with the key.

i - Confirm the buckle is fully locked, you could loose the screw (D) then adjust the buckle position in case the side box is locked too tightly or too loosely. Make sure the screw (D) is fully installed after adjustment.

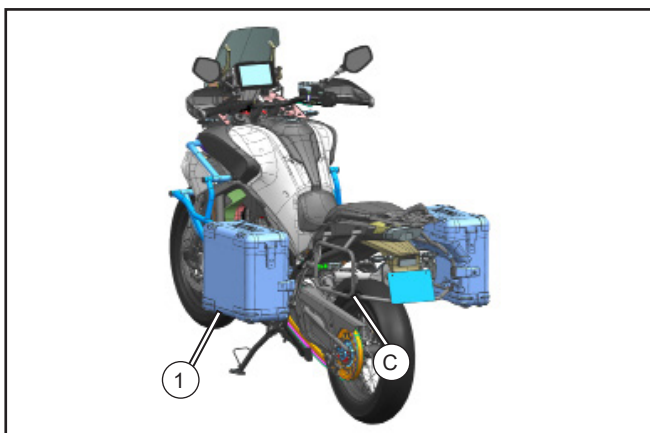

// Position the side box (1) on the left bracket (C).

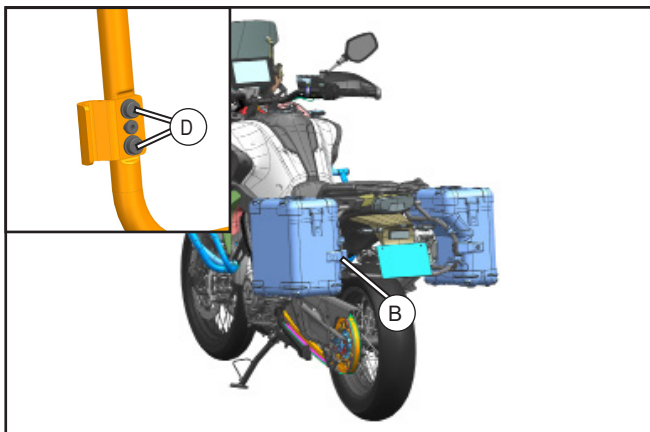

// Lock the shackle (B) to the left bracket, and then lock it with the key.

i - Confirm the buckle is fully locked, you could loose the screw (D) then adjust the buckle position in case the side box is locked too tightly or too loosely. Make sure the screw (D) is fully installed after adjustment.